

FLUTEC VALVES

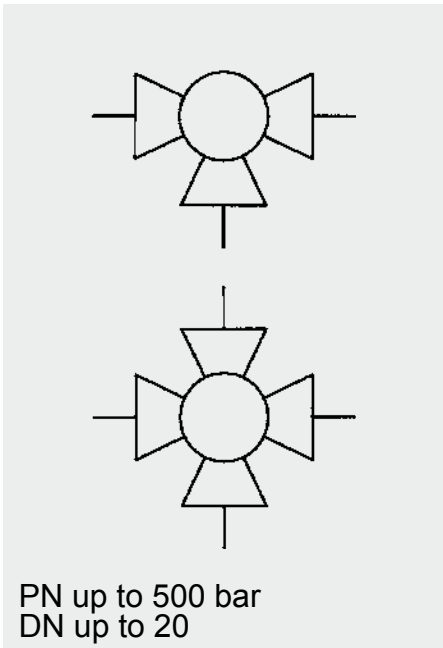

3-Way and 4-Way Ball Valves KH3 / KH4



Model code

(also order example)

KH3 **G1/2** **L** **1114** **06** **X**

Designation

KH3 = 3-way ball valve

KH4 = 4-way ball valve

Nominal bore

Ball bore

KH3 - L

KH3 - T

KH4 - T

KH4 - X

Materials

Housing, connection adapters and control spindle

1 = Steel

3 = Stainless steel

Ball

1 = Steel

3 = Stainless steel

Ball seal

1 = POM

3 = PTFE

8 = PEEK

Control spindle seal

2 = NBR (Perbunan)

3 = PTFE

4 = FKM (Viton)

Handle

01 = Aluminium clamped handle, straight

02 = Aluminium clamped handle, cranked

03 = Zinc die-cast clamped handle, straight

04 = Zinc die-cast bolt-on handle, cranked

06 = Steel bolt-on handle, cranked

09 = Without handle

Series

(determined by manufacturer)

Standard model functions

(Standard)

(Positive switching overlap)

3-way ball valve L-bore

90° switch



3-way ball valve T-bore

90° switch

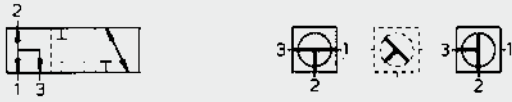

4-way ball valve T-bore

90° switch

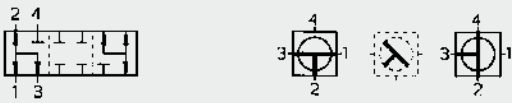

4-way ball valve X-bore

90° switch

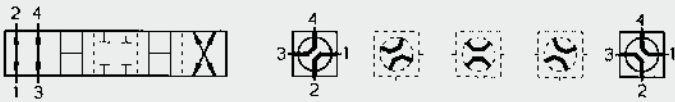

Non-standard model functions

(positive switching overlap)

For different applications, it is possible to produce other non-standard models by using special limit discs and detent pins.

3-way ball valve L-bore, 90° switch, detent at 45°, SO 378

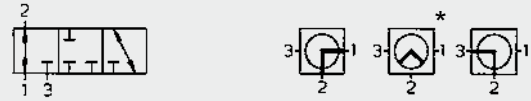

3-way ball valve T-bore, 90° switch, detent at 45°, SO 379

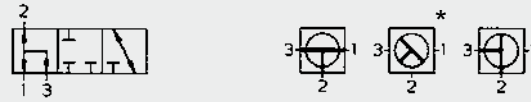

3-way ball valve T-bore, 180° switch, no detent on centre setting

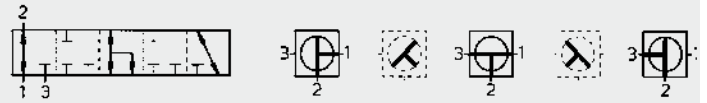

3-way ball valve T-bore, 180° switch, SO 926.1, no detent on centre setting

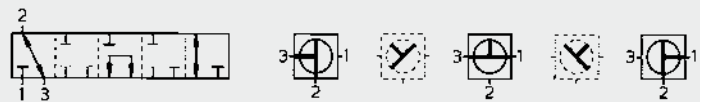

3-way ball valve T-bore, 180° switch, SO 926.2, no detent on centre setting

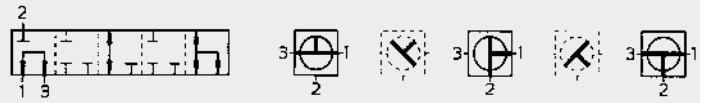

4-way ball valve T-bore, 180° switch, no detent on centre setting

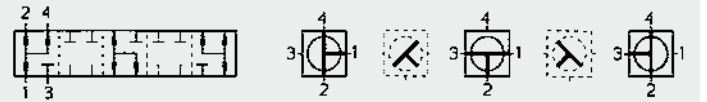

4-way ball valve L-bore, 180° switch, no detent on centre setting

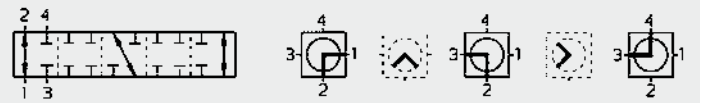

4-way ball valve X-bore, 45° switch, SO 384

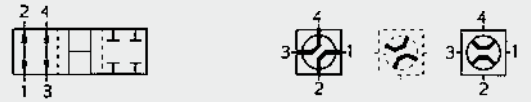

4-way ball valve X-bore, 90° switch with detent position at 45°, SO 385

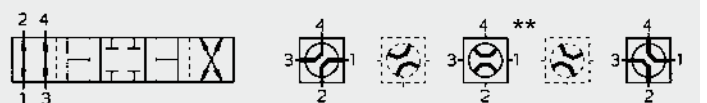

4-way ball valve T-bore, 90° switch with detent position at 45°, SO 389

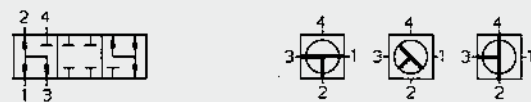

 undefined switching position

* The centre setting is held by a detent pin.

Technical specifications

Types of connection:	Light and heavy threaded pipe connection to DIN 2353 Whitworth female thread to ISO 228 NPT SAE
Mounting position:	Optional
Ambient temperature:	-10 °C to +80 °C
Nominal pressure:	up to PN 500 bar
Operating fluids:	Mineral oil to DIN 51524 Part 1 and Part 2 (other fluids on request)
Temperature of operating fluid:	-10 °C to +80 °C
Spare parts:	Seal kits available on request

Dimensions

3-Way and 4-Way Ball Valves

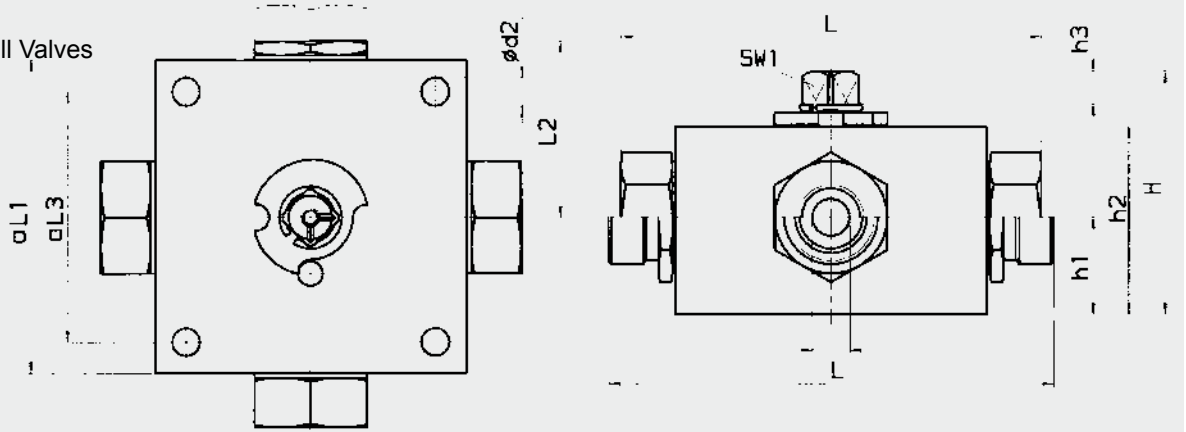

Type	DN	Bore int. Ø			RA	d1	i	L	L1	L2	L3	H	h1	h2	h3	d2	SW1	SW2	Weight [kg]	Nom. press. PN [bar]
KH3/4-G1/8	4	6	6	4.5		G1/8	10	100	70	42.5	55	57	22	40	11	6.5	12	24	1.6	500
KH3/4-G1/4	6	6	6	4.5		G1/4	14	100	70	42.5	55	57	22	40	11	6.5	12	24	1.6	500
KH3/4-G3/8	10	9	9	6		G3/8	14	115	80	46	65	67.5	27	50	11.5	6.5	14	30	2.4	500
KH3/4-G1/2	16	13	13	10		G1/2	16	135	100	56	80	77.5	31	60	11.5	9	14	36	4.3	400
KH3/4-G3/4	20	18	18	14		G3/4	18	144	100	58	85	91	36	73	11.5	9	17	46	6	315

Type	DN	Bore int. Ø			RA	d1	i	L	L1	L2	L3	H	h1	h2	h3	d2	SW1	SW2	Weight [kg]	Nom. press. PN [bar]
KH3/4-06LR	4	6	6	4.5	6	M12x1.5	10	105	70	42.5	55	57	22	40	11	6.5	12	24	1.6	500
KH3/4-08LR	6	6	6	4.5	8	M14x1.5	10	105	70	42.5	55	57	22	40	11	6.5	12	24	1.6	500
KH3/4-10LR	8	9	9	6	10	M16x1.5	11	114	80	46	65	67.5	27	50	11.5	6.5	14	30	2.4	500
KH3/4-12LR	10	9	9	6	12	M18x1.5	11	114	80	46	65	67.5	27	50	11.5	6.5	14	30	2.4	500
KH3/4-15LR	12	13	13	10	15	M22x1.5	12	136	100	56	80	77.5	31	60	11.5	9	14	36	4.3	400
KH3/4-18LR	16	13	13	10	18	M26x1.5	12	136	100	56	80	77.5	31	60	11.5	9	14	36	4.3	400
KH3/4-22LR	20	18	18	14	22	M30x2	14	143	100	58	85	91	36	73	11.5	9	17	46	6	315

Type	DN	Bore int. Ø			RA	d1	i	L	L1	L2	L3	H	h1	h2	h3	d2	SW1	SW2	Weight [kg]	Nom. press. PN [bar]
KH3/4-08SR	4	6	6	4.5	8	M16x1.5	12	105	70	42.5	55	57	22	40	11	6.5	12	24	1.6	500
KH3/4-10SR	6	6	6	4.5	10	M18x1.5	12	105	70	42.5	55	57	22	40	11	6.5	12	24	1.6	500
KH3/4-12SR	8	9	9	6	12	M20x1.5	12	116	80	46	65	67.5	27	50	11.5	6.5	14	30	2.4	500
KH3/4-14SR	10	9	9	6	14	M22x1.5	14	120	80	46	65	67.5	27	50	11.5	6.5	14	30	2.4	500
KH3/4-16SR	12	13	13	10	16	M24x1.5	14	140	100	56	80	77.5	31	60	11.5	9	14	36	4.3	400
KH3/4-20SR	16	13	13	10	20	M30x2	16	144	100	56	80	77.5	31	60	11.5	9	14	36	4.3	400
KH3/4-25SR	20	18	18	14	25	M36x2	18	151	100	58	85	91	36	73	11.5	9	17	46	6	315

Type	DN	Bore int. Ø			RA	d1	i	L	L1	L2	L3	H	h1	h2	h3	d2	SW1	SW2	Weight [kg]	Nom. press. PN [bar]
KH3/4-06NPT	6	6	6	4.5		1/4 - 18 NPT	10.21	100	70	42.5	55	83	22	40	11	6.5	12	24	1.75	500
KH3/4-10NPT	10	9	9	6		3/8 - 18 NPT	10.36	115	80	46	65	63.5	27	50	11.5	6.5	14	30	2.7	500
KH3/4-12NPT	12	13	13	10		1/2 - 14 NPT	13.56	135	100	56	85	75.5	31	60	11.5	9	14	36	4.8	400
KH3/4-20NPT	20	18	18	14		3/4 - 14 NPT	13.86	144	100	58	85	92	36	73	11.5	9	17	46	6.3	315

Type	DN	Bore int. Ø			RA	d1	i	L	L1	L2	L3	H	h1	h2	h3	d2	SW1	SW2	Weight [kg]	Nom. press. PN [bar]
KH3/4-10SAE	10	9	9	6		9/16-18 UNF	13	115	80	46	65	63.5	27	50	11.5	6.5	14	30	2.68	500
KH3/4-12SAE	12	9	9	10		3/4-16 UNF	15	135	100	56	80	75.5	31	60	11.5	9	14	36	4.75	400
KH3/4-20SAE	20	13	13	14		1 1/16 - 12 UN	20	144	100	58	85	91	36	73	10.5	9	17	46	6.1	315